

OFT

OPTICAL FLUTING TEST



BalaguerRolls
High Quality Centrifugally Cast Rolls







OPTICAL FLUTING TEST 4.0

The Optical Fluting Test is the world's only device able to check rolls profiles by optical vision without roll contact.







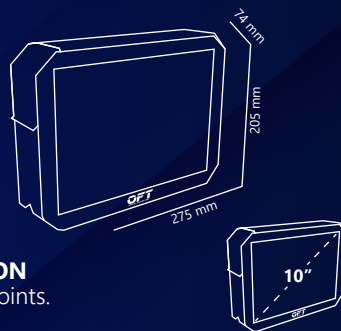

The millers get a certificate which will show the existing fluting profile of a specific roll, in order to help them to take the decision of changing the rolls at the most suitable and cost-effective time.

NEW FEATURES

- 
MULTIPLE SHOOT
Multiple pictures are taken at once for optimal image resolution.
- 
AUTOMATIC CONTOUR DETECTION
Effortless placement of measuring points.
- 
FULLY AUTONOMUS DEVICE
No laptop needed. Just by pressing the button the wear out is calculated.
- 
AUTOMATIC RECOVERY OF THEORETICAL DATA
When entering a roll, if it has already been analyzed, all the theoretical data is automatically loaded, which avoids having to enter it again.
- 
ROLL HISTORY DISPLAY
When a cylinder number is entered, the history of all measurements made on that roll automatically appears.





MAIN FEATURES

- 
Faster algorithm. Improved and more precise wear out analysis.
- 
Flute contour detection on OFT
- 
Excellent accuracy in all type of flutes
- 
Longer market availability
- 
Bigger and better quality screen
- 
Totally portable
- 
Faster measurement and image adquisition
- 
Easier to use. Interface improved



www.balaguer-rolls.com

 Facebook
  Youtube
  LinkedIn



BalaguerRolls
High Quality Centrifugally Cast Rolls



OFT
OPTICAL FLUTING TEST

Measurements taken

The Optical Fluting Test enables the operator to measure the following elements of a roll profile: pitch, land, radius, dull angle, sharp angle and wearout.

Advanced measurement

Accurate measurement of the flutes shape recorded without having contact with the roll surface, being safe and easy to use and transport as well as much more accurate than other existing devices such as magnifying glass or profilometer.

Purpose of the device

It is an optical measuring device that allows us to quickly and accurately check the state of the flutes in the roll. Fluting parameters with a 2.2μ accuracy in dimensional measurements and a ± 0.01 accuracy in angle measurements can be obtained.

MAIN BENEFITS

- ▶ Tells millers when to change or reflute the rolls.
- ▶ Makes management easier to plan future needs of rolls.
- ▶ Reduces time of the mill maintenance period.
- ▶ Gives more efficiency in the use of rolls information, and accuracy.
- ▶ Increases the safety of the mills by knowing the state of the flutes in the roll.

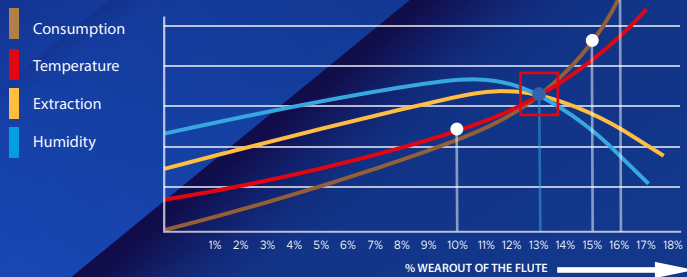

www.balaguer-rolls.com

Facebook Youtube LinkedIn



BalaguerRolls
High Quality Centrifugally Cast Rolls